

# Fenster in Holz-Metall

3p-864-68 B

*Detail unten*

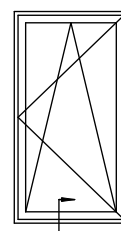
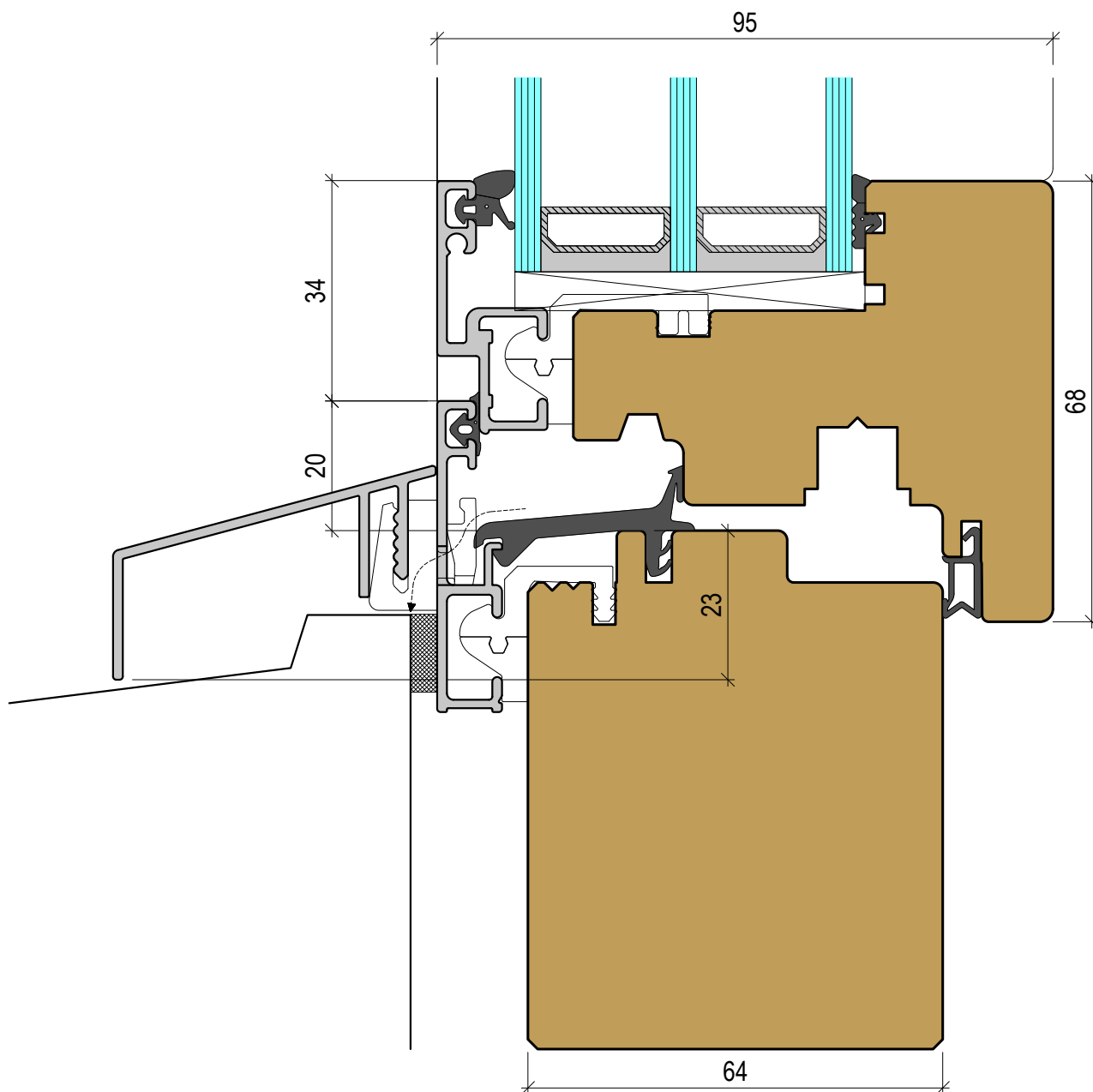

3p-864-68 B 201

# Fenster in Holz-Metall

3p-864-68 B

*Detail unten*

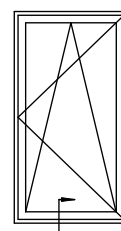
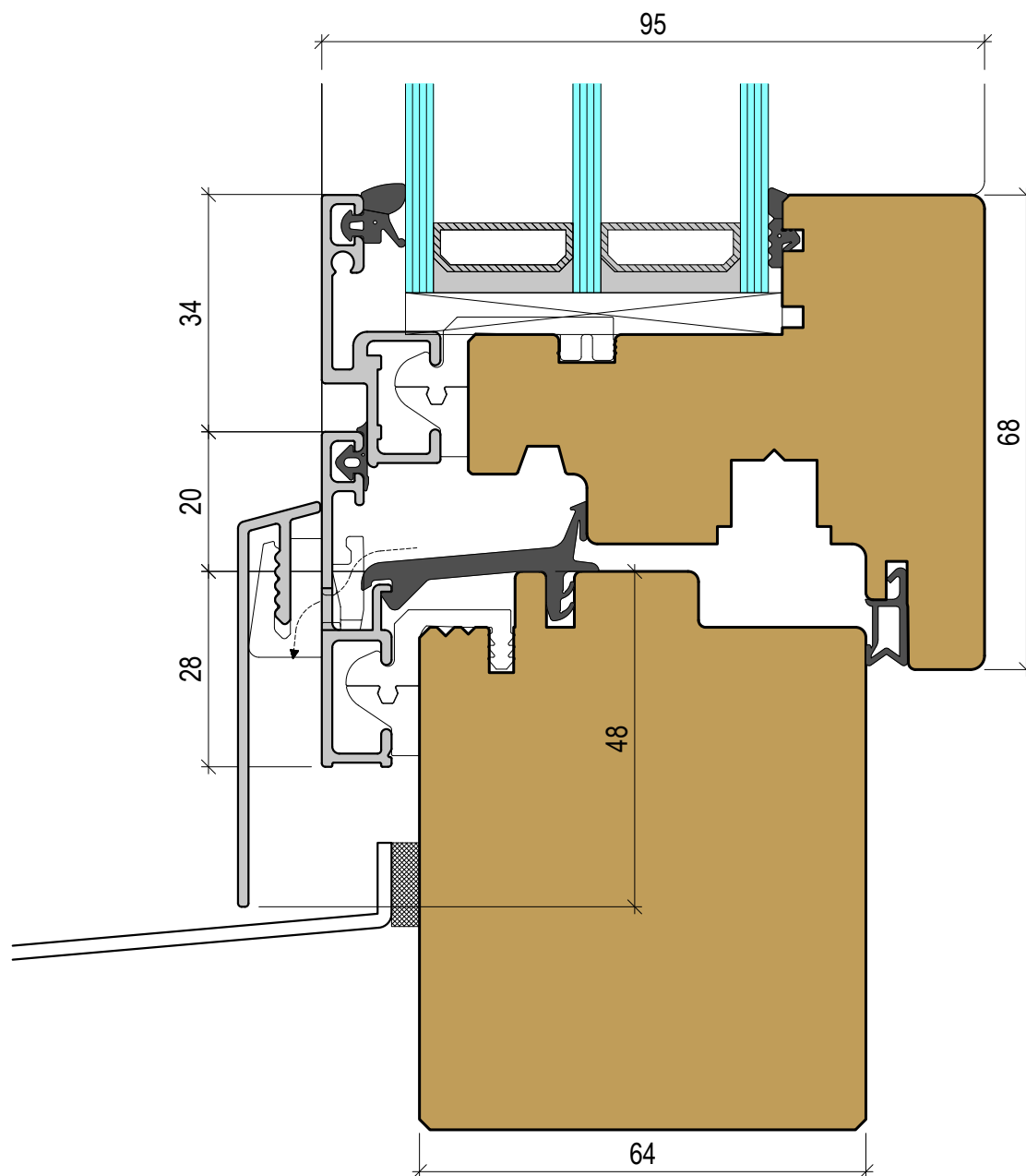

3p-864-68 B 202

# Fenster in Holz-Metall

3p-864-68 B

Detail unten

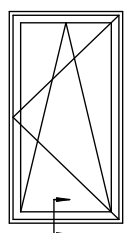
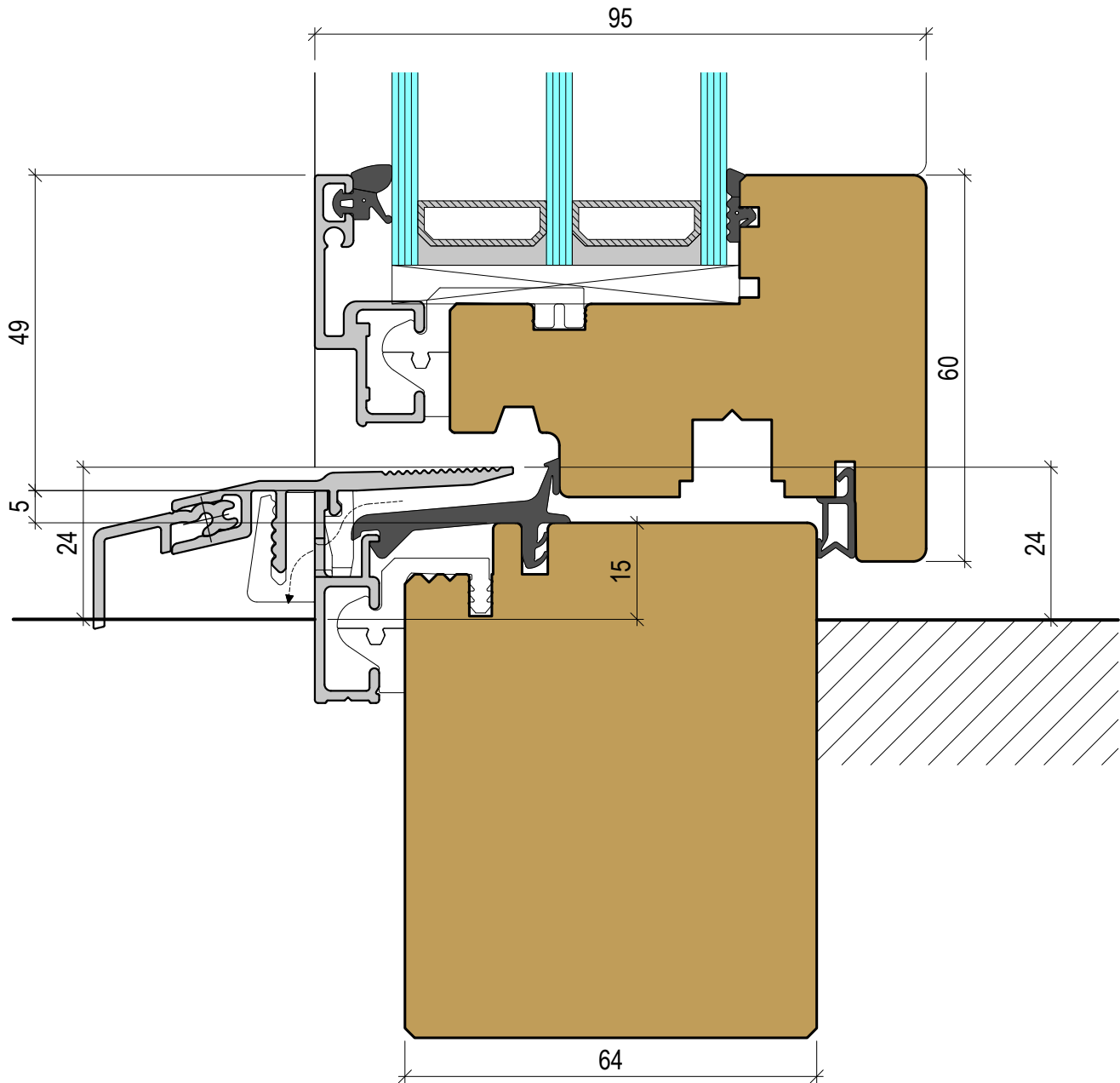

3p-864-68 B 204

# Fenster in Holz-Metall

3p-864-68 B

*Detail unten*

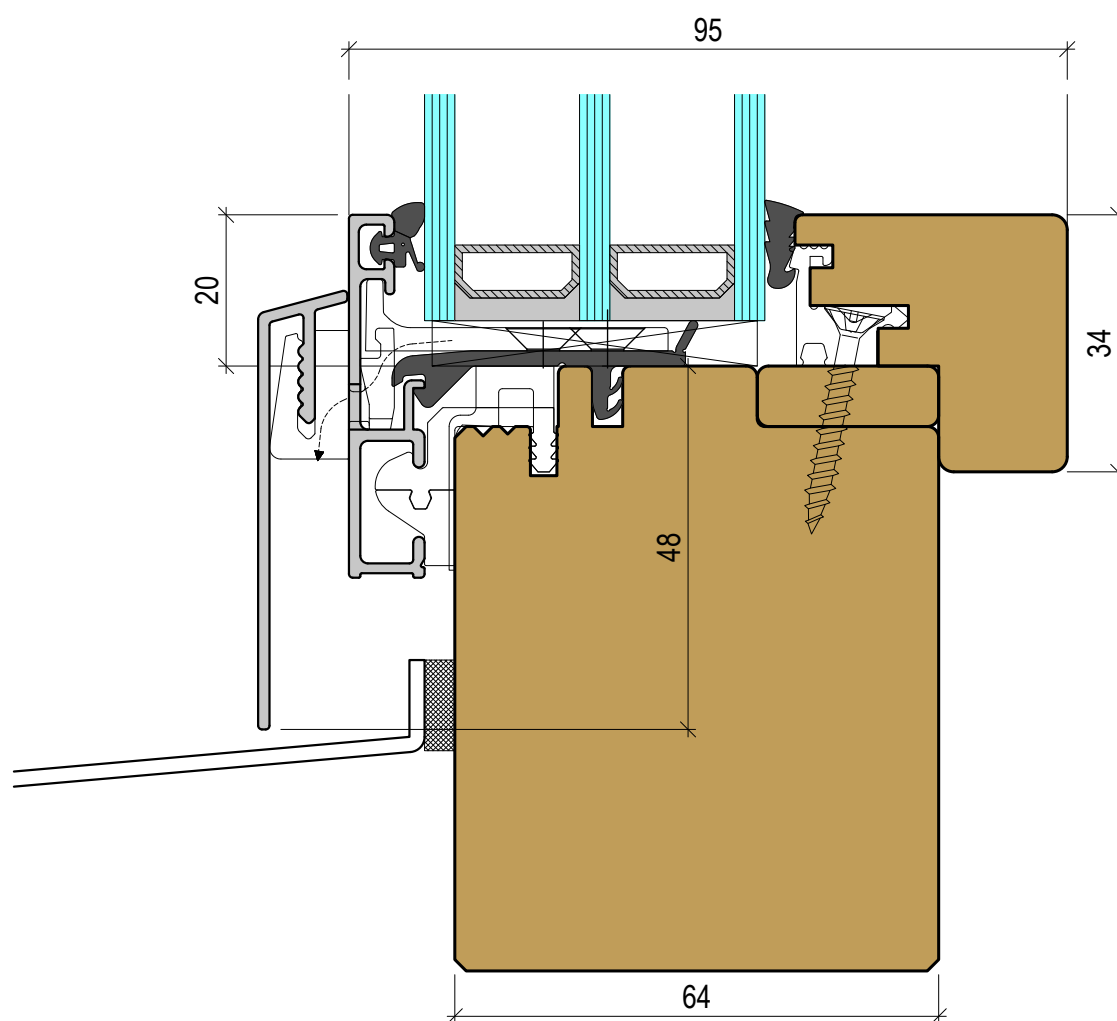

3p-864-68 B 206

# Fenster in Holz-Metall

3p-864-68 B

*Detail unten*

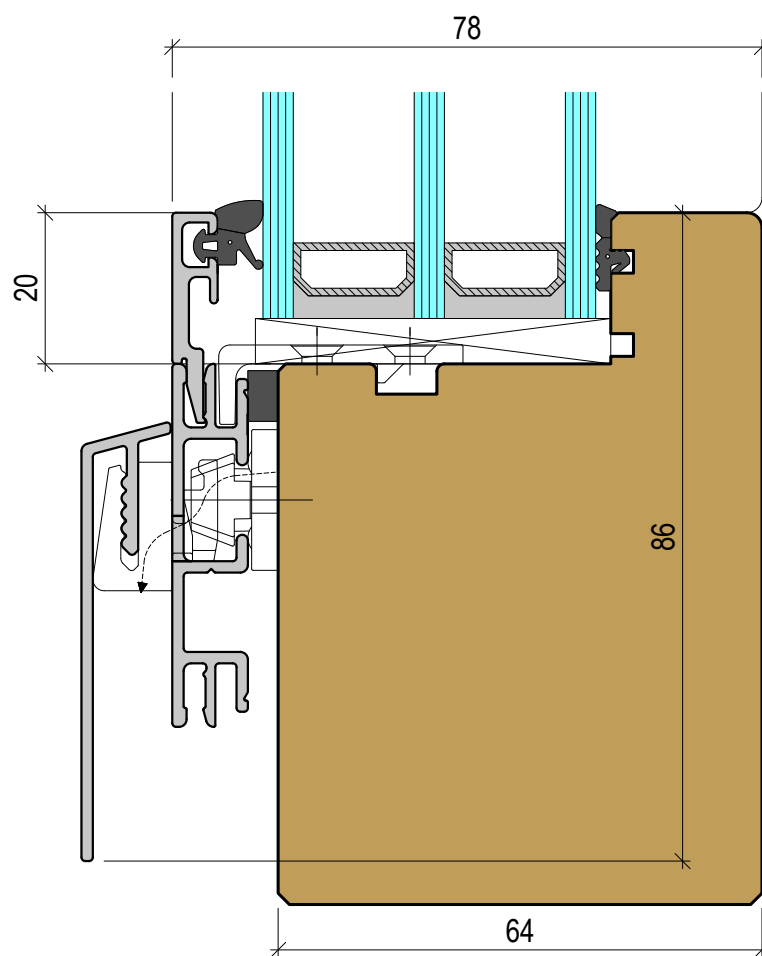

3p-864-68 B 208

# Fenster in Holz-Metall

3p-864-68 B

Detail seitlich

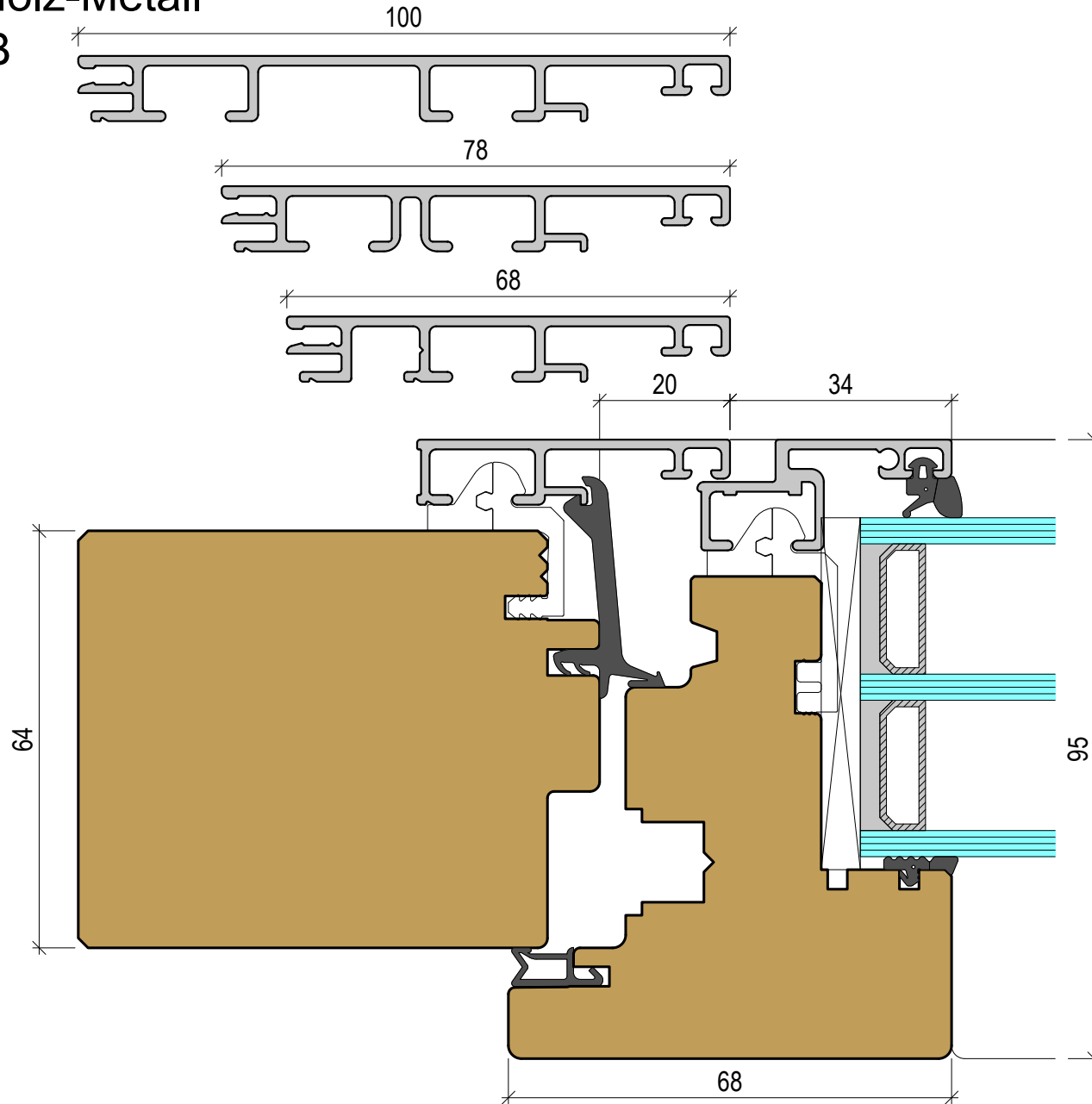

# Fenster in Holz-Metall

3p-864-68 B

*Detail seitlich*

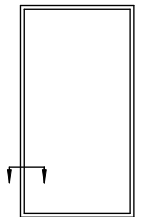
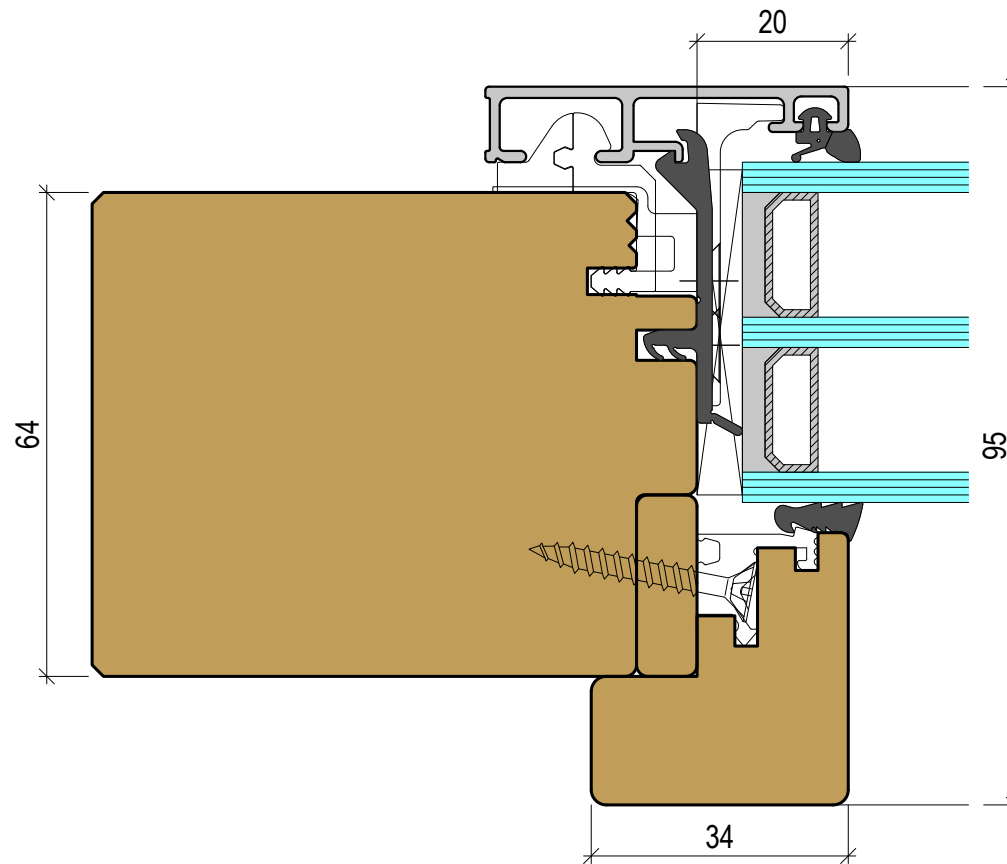

3p-864-68 B 305

# Fenster in Holz-Metall

## 3p-864-68 B

*Detail seitlich*

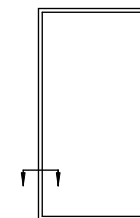
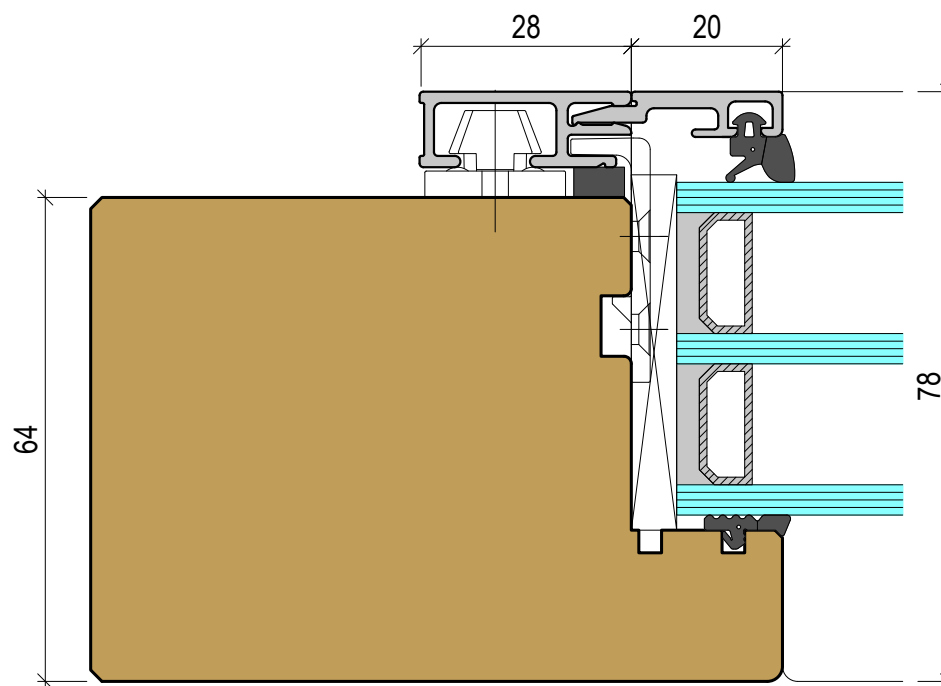

3p-864-68 B 308



# Fenster in Holz-Metall

3p-864-68 B

*Detail Mittelpartie (Stulp)*

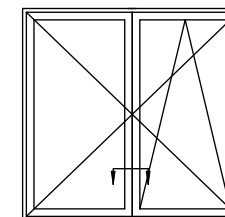
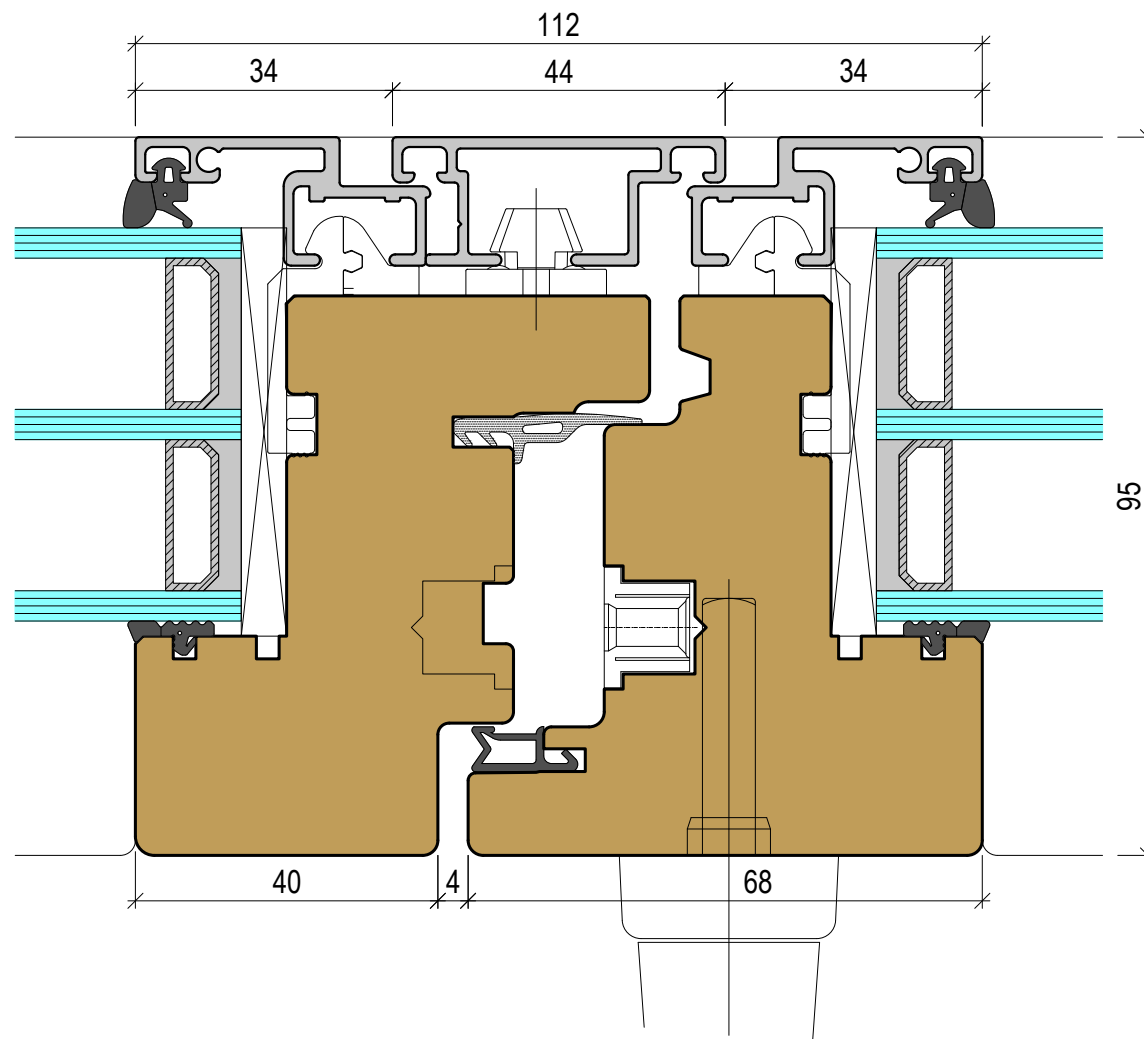

3p-864-68 B 401

# Fenster in Holz-Metall

## 3p-864-68 B

### Detail Setzholz

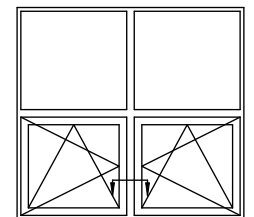
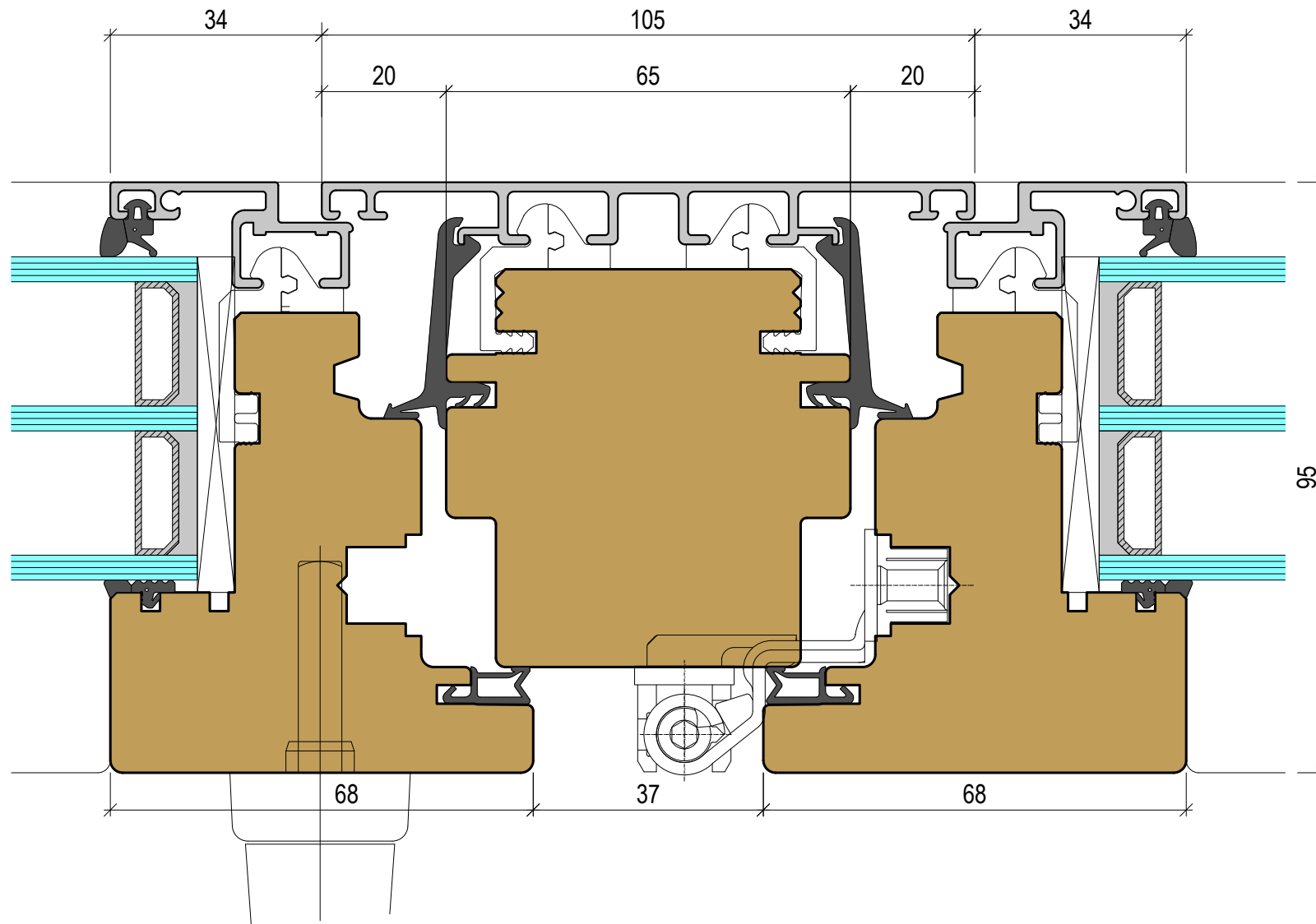

3p-864-68 B 501

Fenster in Holz-Metall  
3p-864-68 B  
*Detail Kämpfer*

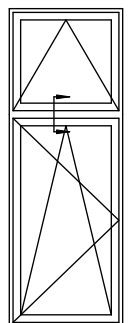
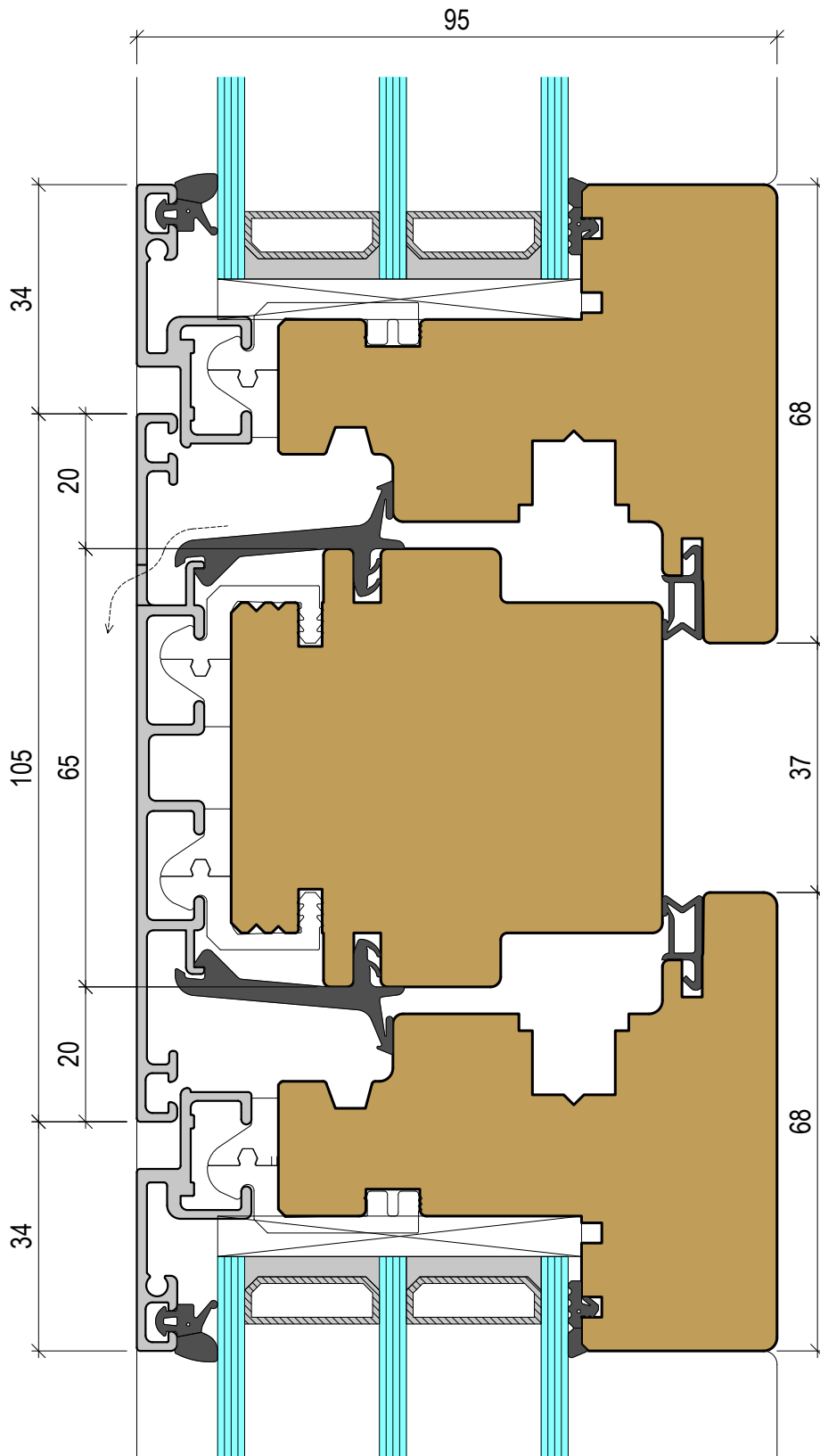

3p-864-68 B 601